

T 8359 EN

Type 4763 Electropneumatic Positioner

Type 4765 Pneumatic Positioner



Application

Single-acting positioners for attachment to pneumatic control valves. These positioners use an electric input signal from 0/4 to 20 mA or 1 to 5 mA (Type 4763) or a pneumatic input signal from 0.2 to 1 bar (3 to 15 psi) (Type 4765).

Rated travels from 7.5 to 90 mm

The positioners ensure a predetermined assignment of the valve position (controlled variable x) to the input signal (reference variable w). They compare the input signal received from a control system to the travel of the control valve and issue a corresponding output signal pressure p_{st} (output variable y).

Special features

- Compact, low-maintenance design
- Any mounting position possible
- Insusceptible to mechanical vibrations
- Reversible direction of action
- Excellent dynamic behavior
- Suitable for normal or split-range operation
- Adjustable proportional band (P-band)
- Adjustable air output capacity
- Low air consumption
- Version with two pressure gauges to monitor supply air and signal pressure (stainless steel pressure gauge housing with connections either nickel-plated or made of stainless steel)

A Type 4765 Pneumatic Positioner can be upgraded to a Type 4763 Electropneumatic Positioner.

Attachment according to IEC 60534-6 and NAMUR

The various ways in which the positioner can be attached to the actuator meet the requirements of IEC 60534-6 and NAMUR recommendation. Positioners may be attached to valves with either cast yokes (e.g. SAMSON Series 240) or rod-type yokes.

Each type of attachment requires special mounting parts

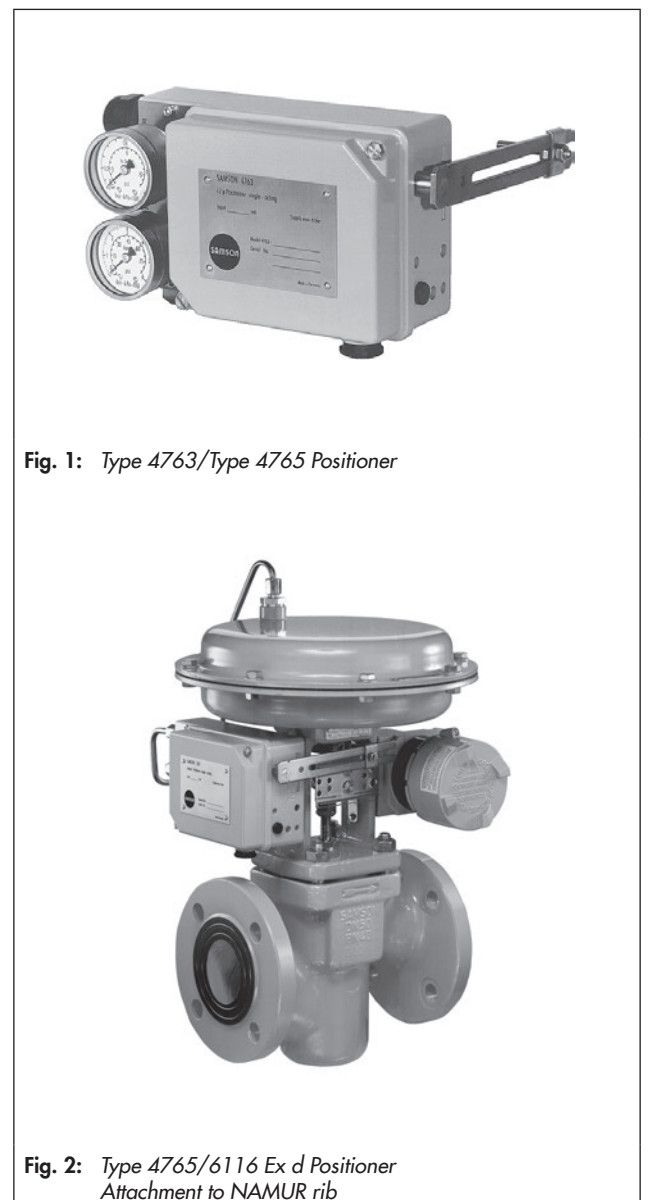

Fig. 1: Type 4763/Type 4765 Positioner

Fig. 2: Type 4765/6116 Ex d Positioner
Attachment to NAMUR rib

Versions

Type 4763-0 (Fig. 1) · Electropneumatic positioner, without explosion protection

Type 4763-1 · Electropneumatic positioner for hazardous areas

Input circuit II 2G Ex ia IIC T6 Gb according to ATEX

Type 4763-8 · Electropneumatic positioner in Ex nA (non-sparking)

Type 4765/6116 (Fig. 2) · Electropneumatic positioner with type of protection "Flameproof enclosure" Ex d with Type 6116 i/p Converter

Type 4765 (Fig. 1) · Pneumatic positioner with 0.2 to 1 bar (3 to 15 psi) reference variable

Principle of operation

The only difference between the Type 4765 Pneumatic Positioner and the Type 4763 Electropneumatic Positioner is the electropneumatic (i/p) converter unit in the electropneumatic positioner to convert the electric signal from the controller into a proportional pneumatic signal.

The positioners use a flapper-nozzle system which operates according to the force-balance principle. They can be applied for both normal and split-range operation.

Direction of action

When the reference variable increases, the signal pressure can be selected to be increasing/increasing (direct action \gg) or increasing/decreasing (reverse action \ll). The direction of action depends on the position of the nozzle assembly that can be turned by 180° . The visible marking (\gg or \ll) indicates which direction of action is effective. On changing the direction of action or the fail-safe position, note that the positioner must also be mounted in a different position (Fig. 4 to Fig. 7).

Assignment of the positioner and the actuator

Fig. 4 to Fig. 7 schematically illustrate the arrangement of the actuator, mounting position of the positioner, reference variable, and direction of action.

Fail-safe position

The Type 3271 and Type 3277 Pneumatic Actuators are available with the following fail-safe actions which become effective when the pressure is relieved from the diaphragm or the air supply fails:

Actuator stem extends (Fig. 4/Fig. 5)

The compression springs in the actuator force the actuator stem to extend when the pressure acting on the diaphragm decreases or upon air supply failure.

Actuator stem retracts (Fig. 6/Fig. 7)

The compression springs in the actuator force the actuator stem to retract when the pressure acting on the diaphragm decreases or upon air supply failure.

Refer to Data Sheets ▶ T 8310-1 and ▶ T 8310-2 for more details.

Fig. 4 to Fig. 7 illustrate the different directions of action and the mounting positions of the positioner. Right and left attachment apply when looking onto the lever (1) and plate (2).

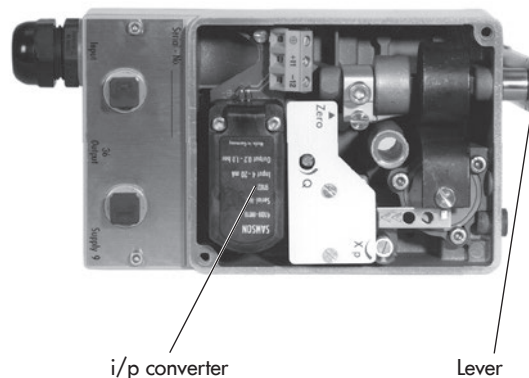

Fig. 3: Type 4763 Positioner

Actuator stem extends

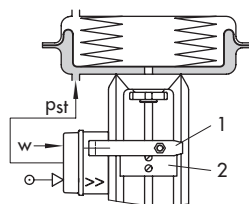

Fig. 4: Direction of action \gg
Left attachment

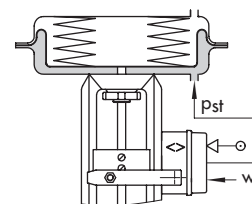

Fig. 5: Direction of action \ll
Right attachment

Actuator stem retracts

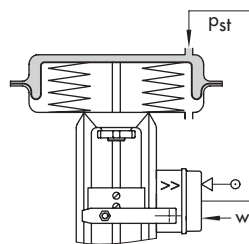

Fig. 6: Direction of action \gg
Left attachment

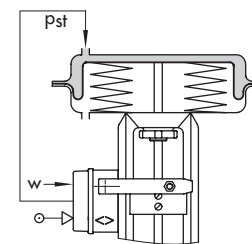

Fig. 7: Direction of action \ll
Right attachment

Table 1: Technical data · Type 4765 Pneumatic Positioner

Type 4765	
Controlled variable (travel range)	7.5 to 60 mm, With lever extension: 7.5 to 90 mm
Reference variable	0.2 to 1 bar (3 to 15 psi)
Split-range 0 to 50 % or 50 to 100 % reference variable span (up to 50 mm travel)	0.2 to 0.6 bar (3 to 9 psi) and 0.6 to 1 bar (9 to 15 psi)
Range spring	See Table 3 on page 5 for selection
Supply air	Supply air: 1.4 to 6 bar (20 to 90 psi) Air quality acc. to ISO 8573-1: Max. particle size and density: Class 4 Oil content: Class 3 · Pressure dew point: Class 3
Signal pressure p_s (output)	Max. 0 to 6.0 bar (0 to 90 psi)
Characteristic	Linear characteristic Deviation from characteristic according to terminal point method ≤ 1.5 %
Hysteresis	< 0.5 %
Sensitivity	< 0.1 %
Direction of action	Reversible
Proportional band X_p (at 1.4 bar supply air)	1 to 3.0 % with spring 1 1 to 2.0 % with spring 2 1 to 1.5 % with spring 3
Air consumption in steady state, $X_p = 1$ %	With 1.4 bar supply air: $0.13 \text{ m}_n^3/\text{h}$ With 6 bar supply air: $0.33 \text{ m}_n^3/\text{h}$
Air output	At Δp 1.4 bar: $3.0 \text{ m}_n^3/\text{h}$ At Δp 6 bar: $8.5 \text{ m}_n^3/\text{h}$
Transit time with Type 3271 Actuator, "stem extends"	$240 \text{ cm}^2 \leq 1.8 \text{ s}$ $350 \text{ cm}^2 \leq 2.5 \text{ s}$ $700 \text{ cm}^2 \leq 10 \text{ s}$
Permissible ambient temperature ¹⁾	-20 to $+80$ °C
Influences	Temperature: < 0.02 %/1 K Supply air: < 0.20 %/0.1 bar Variable position when turned by 180° : < 3.50 %
Degree of protection	IP 54 · Venting over check valve (1790-7408): IP 65
Compliance	CE
Weight	Approx. 1.1 kg
Materials	Housing: die-cast aluminum, chromated, and plastic coated External parts: stainless steel

¹⁾ Extended temperature range on request

Table 2: Technical data · Type 4763 Electropneumatic Positioner

Type 4763	
Controlled variable (travel range)	7.5 to 60 mm, with lever extension: 7.5 to 90 mm
Reference variable ¹⁾ Split-range 0 to 50 % or 50 to 100 % reference variable span (up to 50 mm travel)	4 to 20 mA (Ex), $R_i = 250 \Omega$ ²⁾ 4 to 20 mA (without explosion protection), $R_i = 200 \Omega$ ²⁾ 0 to 20 mA, $R_i = 200 \Omega$ ²⁾ 1 to 5 mA, $R_i = 880 \Omega$ ²⁾
Range spring	See Table 3 on page 5 for selection
Supply air	Supply air: 1.4 to 6 bar (20 to 90 psi) Air quality acc. to ISO 8573-1: Max. particle size and density: Class 4 Oil content: Class 3 · Pressure dew point: Class 3
Signal pressure p_{st} (output)	Max. 0 to 6.0 bar (0 to 90 psi)
Characteristic	Linear characteristic Deviation from characteristic according to terminal point method $\leq 1.5 \%$
Hysteresis	$< 0.5 \%$
Sensitivity	$< 0.1 \%$
Direction of action	Reversible
Proportional band X_p (at 1.4 bar supply air)	1 to 3.0 % with spring 1 1 to 2.0 % with spring 2 1 to 1.5 % with spring 3
Air consumption in steady state, $X_p = 1 \%$	With 1.4 bar supply air: $0.19 \text{ m}_n^3/\text{h}$ With 6 bar supply air: $0.5 \text{ m}_n^3/\text{h}$
Air output	At Δp 1.4 bar: $3.0 \text{ m}_n^3/\text{h}$ At Δp 6 bar: $8.5 \text{ m}_n^3/\text{h}$
Transit time with Type 3271 Actuator, "stem extends"	$240 \text{ cm}^2 \leq 1.8 \text{ s}$ $350 \text{ cm}^2 \leq 2.5 \text{ s}$ $700 \text{ cm}^2 \leq 10.0 \text{ s}$
Permissible ambient temperature ³⁾	With Type 6109 i/p Converter: -20 to +70 °C -35 to +70 °C (metal cable gland) With Type 6112 i/p Converter: -20 to +80 °C -40 to +80 °C (metal cable gland) -45 to +80 °C (special version)
Influences	Temperature: $< 0.03 \%/1 \text{ K}$ Supply air: $< 0.3 \%/0.1 \text{ bar}$ Vibrations: $< 2 \%$ between 10 up to 150 Hz and 4 g Variable position when turned by 180°: $< 3.5 \%$
Degree of protection	IP 54 · Venting over check valve (1790-7408): IP 65
Compliance	CE · EAC
Electromagnetic compatibility	Complying with EN 61000-6-2, EN 61000-6-3 and EN 61326-1
Weight	Approx. 1.2 kg
Materials	Housing: die-cast aluminum, chromated, and plastic coated External parts: stainless steel

¹⁾ The data listed in the certificate of conformity applies to the version with type of protection Ex ia IIC.

²⁾ R_i = Coil resistance (at approx. 20 °C) $\pm 7 \%$ tolerance

³⁾ Observe the limits in the certificate of conformity for explosion-protected versions.

Table 3: Assignment of lever and range spring

Lever	Rated travel	Min./max. travel	Reference variable (input signal)	Range spring
Lever length L: 40 to 127 mm	15 mm	7.5 to 15 mm	100 % 50 %	1 2
	30 mm	14 to 32 mm	100 % 50 %	2 3
	60 mm	30 to 70 mm	100 %	3
Lever length L with extension: 40 to 200 mm	20 mm	7.5 to 26 mm	100 % 50 %	1 2
	40 mm	14 to 50 mm	100 % 50 %	2 3
	>60 mm	30 to 90 mm	100 %	3

Table 4: Summary of explosion protection approvals

Type	Certification			Type of protection/comments
4763-1	ATEX	Number	PTB 02 ATEX 2078	II 2G Ex ia IIC T6 Gb
		Date	2002-07-19	
4763-3	EAC	Number	RU C DE.08.00697	1Ex ia IIC T6/T5/T4 Gb X
		Date	2014-12-15	
		Valid until	2019-12-14	
4763-3	CSA	Number	1607873	Ex ia IIC T6; Class I, Zone 0 Class I, II, Div. 1, Groups A, B, C, D, E, F, G Class I, II, Div. 2, Groups A, B, C, D, E, F, G
		Date	2005-09-16	
4763-3	FM	Number	3020228	Class I, Zone 0 AEx ia IIC Class I, II, III, Div. 1, Groups A, B, C, D, E, F, G Class I, Div. 2, Groups A, B, C, D Class II, Div. 2 Groups F, G; Class III
		Date	2005-02-28	
4763-8	ATEX	Number	PTB 03 ATEX 2183 X	II 3G Ex nA ic IIC T6 Gc
		Date	2003-09-30	
4763-8	EAC	Number	RU C DE.08.00697	2Ex nA IIC T6/T5/T4 Gc X
		Date	2014-12-15	
		Valid until	2019-12-14	

Article code of Type 4763

Electropneumatic positioner	Type 4763-	x	1	x	x	x	x	x	x	x	0	x	0	x	x
Explosion protection ¹⁾															
Without		0													
Intrinsic safety: ATEX, GOST		1													
Intrinsic safety: CSA, FM		3													
Non-sparking equipment: ATEX, GOST		8													
Spring															
Spring 1, travel = 15 mm			1												
Spring 2, travel = 30 mm, split range 15 mm			2												
Spring 3, travel = 60 mm, split range 30 mm			3												
Housing version															
Standard				0	0										
Pneumatic connections															
ISO 228-1 G ¼						1									
¼-18 NPT						3									
ISO 7/1-Rc ¼						4									
Electrical connection (cable gland)															
ISO 228-1 G ½							0								
M20x1.5 blue (plastic)							1								
M20x1.5 black (plastic)							2								
M20x1.5 blue (metal)							6								
M20x1.5 (nickel-plated brass)							7								
i/p converter module															
Type 6109								1							
Type 6112								2							
Reference variable															
4 to 20 mA									0						
0 to 20 mA									2						
1 to 5 mA									3						
Temperature range															
Standard										0					
Low temperature down to -45 °C										2					
Special version															
Without											0	0	0		
GOST-EAC certificate; IP 66 up to -30 °C											0	0	9		
GOST-EAC certificate; IP 66 up to -45 °C											0	1	0		
Reference variable 0 to 5 mA											0	1	1		
Nameplate (metal)											0	1	7		

¹⁾ See Table 4 for details on explosion protection certificates.

Article code of Type 4765

Pneumatic positioner	Type 4765-	0	1	x	0	0	x	1	x	0
Spring										
Spring 1, travel = 15 mm				1						
Spring 2, travel = 30 mm, split range 15 mm				2						
Spring 3, travel = 60 mm, split range 30 mm				3						
Pneumatic connections										
ISO 228/1 G ¼							1			
¼-18 NPT							3			
Temperature range										
Standard									0	
Low temperature down to -50 °C									1	

Electrical connection and dimensions in mm

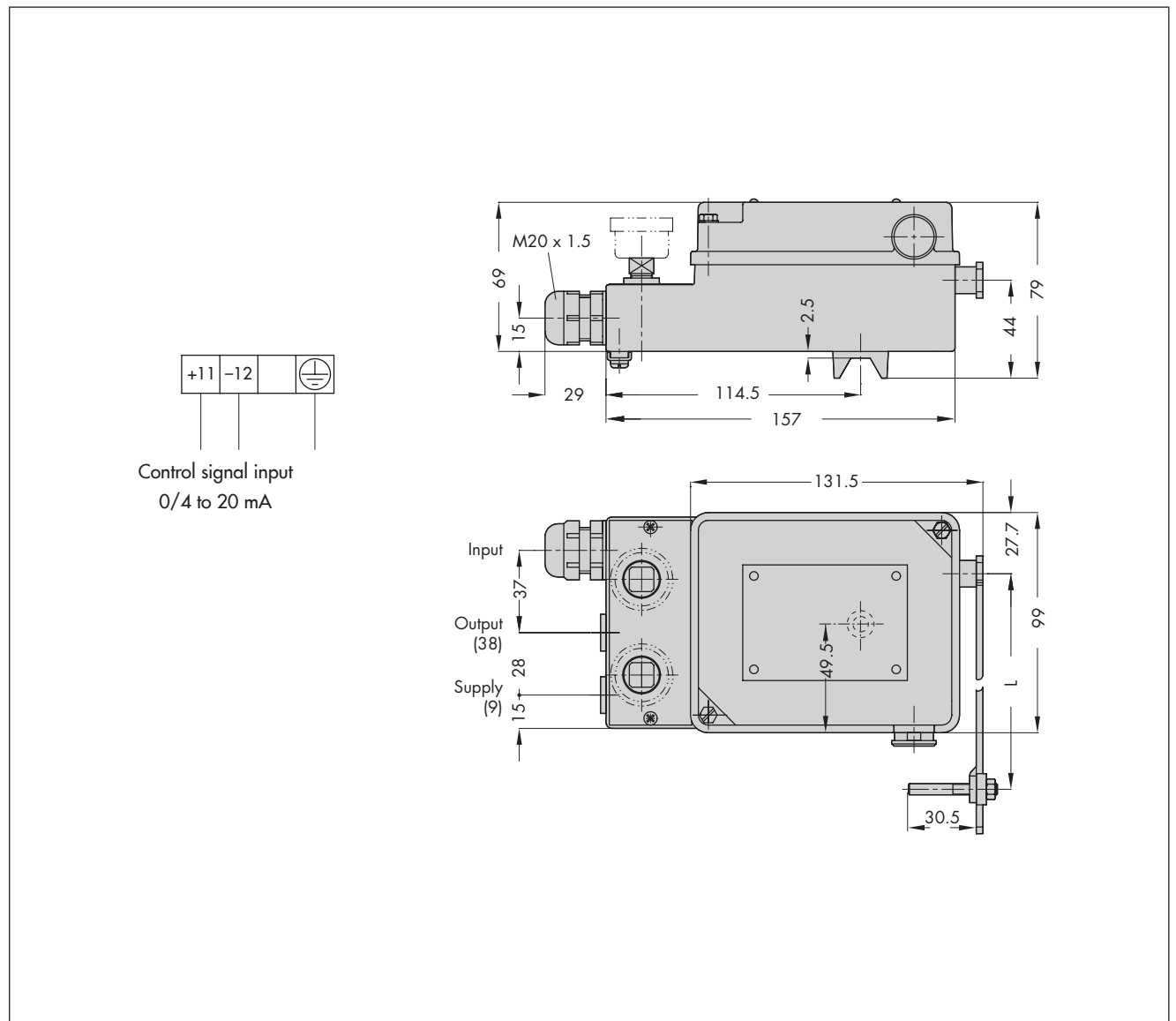

Ordering text

Type 4763-x... Electropneumatic Positioner

or

Type 4765-01... Pneumatic Positioner

Additional specifications

- Without/with pressure gauges
- CrNiMo steel pressure gauge housing, connection nickel-plated or completely of CrNiMo steel for mounting onto control valve
- Reference variable adjusted ... or supply pressure ... bar
- Direction of action: increasing/increasing or increasing/decreasing
- Piping: Zinc-coated steel or completely of CrNiMo steel or natural PE tubing DN 6/10
- Attachment according to IEC 60534-6 (NAMUR)
Travel: ... mm, if applicable, rod diameter: ...mm
Optionally, special version
- Extended temperature range

Refer to the following mounting and operating instructions concerning the mounting parts required when the positioner is delivered separately and not mounted onto a control valve:

- Type 4765: ► EB 8359-1
- Type 4763: ► EB 8359-2